

# THE OUTDOOR EXPERTS

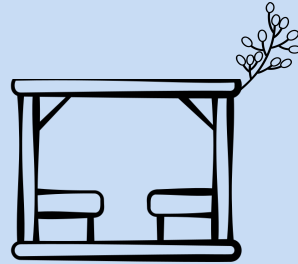

THE OUTDOOR COMPANY



Κατά τη διάρκεια 45 χρόνων εμπειρίας, η εταιρία Inox Nossis ήταν πάντα ο πρωταγωνιστής των κατασκευών για το εξωτερικό περιβάλλον. Αυτό της επέτρεψε να δημιουργήσει καινοτόμες λύσεις όπως παραστρόμενα παράθυρα. Κατασκευές που έχουν φέρει επανάσταση στον τρόπο εμπειρίας των υπαίθριων χώρων διαβίωσης. Πιστοί στο όραμα μας και με σεβασμό στην παράδοση προχωράμε σε νέα καινοτόμα προϊόντα ανταποκρινόμενοι στους περιβαλλοντικούς στόχους και τις σύγχρονες ανάγκες των πελατών μας. Για αυτούς τους λόγους δημιουργούμε και προτείνουμε τα παρασυρόμενα παράθυρα.

For 45 years, Inox Nossis has always been the protagonist of an advanced connection to the outdoor environment. This allowed us to create innovative solutions such as retractable windows, constructions that have revolutionized the way of experiencing outdoor living spaces. Faithful to our vision and respect for our tradition, we move forward with new innovative products responding to the environmental goals and the modern needs of our customers. For these reasons we create and propose the sliding system.



## ΜΕΓΙΣΤΗ ΕΞΑΤΟΜΙΚΕΥΣΗ ΓΙΑ ΟΛΑ ΜΑΣ ΤΑ ΠΡΟΪΟΝΤΑ

Ολόκληρος ο σχεδιασμός βασίζεται πάνω στις απαιτήσεις του πελάτη.

Η εταιρεία μας παρέχει ειδικές υπηρεσίες αρχιτεκτονικού σχεδιασμού.

Αποτυπώνουμε το χώρο σας, δημιουργούμε κατασκευαστικά σχέδια και αρχιτεκτονικό φωτορεαλισμό (3D απεικόνιση), με σκοπό να οραματιστείτε το τελικό αποτέλεσμα.

## MAXIMUM CUSTOMIZATION FOR ALL PRODUCTS

The whole planning and engineering product process is built around customer requirements.

Our company provides special services of architectural design .

The whole project is imprinted in 2D and 3D photorealistic plans, so you can envision the final result.



## ΤΟΠΟΘΕΤΗΣΗ

Την τοποθέτηση των προϊόντων μας αναλαμβάνει εξειδικευμένο προσωπικό.

## INSTALLATION

The installation of our products exclusively run by highly trained staff.

# SLIDING



THE OUTDOOR COMPANY

## ΠΕΡΙΕΧΟΜΕΝΑ | CONTENTS

2	Εισαγωγή
3	Περιεχόμενα
4	Παρασυρόμενα Παράθυρα
5-9	Πλεονεκτήματα
10-13	Τεχνικά Χαρακτηριστικά
	<u>ΜΟΝΟ ΚΡΥΣΤΑΛΛΟ</u>
14-17	(3-κανάλια) - Πιθανοί συνδυασμοί
18-22	(5-κανάλια) - Πιθανοί συνδυασμοί
	<u>ΔΙΠΛΟ ΚΡΥΣΤΑΛΛΟ</u>
23-27	(4-κανάλια) - Πιθανοί συνδυασμοί
28	Χρωματικές επιλογές





## SLIDING

ΜΟΝΟ & ΔΙΠΛΟ ΚΡΥΣΤΑΛΛΟ

**GR** Τα συρόμενα συστήματα είναι κατάλληλα για ιδιωτικούς και επαγγελματικούς χώρους και έχουν σχεδιαστεί προκειμένου να προστατεύουν την περιοχή από βροχή, άνεμο και κρύο.

Ο ωφελούμενος χώρος που αποκτάτε με αυτόν τον τρόπο μπορεί να ανοιχτεί ολοκληρωτικά το καλοκαίρι.

Τα συρόμενα κρύσταλλα συνδυάζουν τη μέγιστη πρακτικότητα με την αισθητική, αφού ταιριάζουν σε οποιοδήποτε αρχιτεκτονικό πλαίσιο.

Ένα προφίλ αλουμινίου υψηλής αντοχής και δύο πλαϊνές κλειδαριές παρέχουν ασφάλεια κατά οποιασδήποτε επιπλοκής.

**EN** Sliding systems are suitable for private and commercial spaces and are designed to protect the area from rain, wind and cold.

The useful space you get in this way can be completely opened in the summer.

Sliding crystals combine maximum practicality with aesthetics, as they fit into any architectural context.

A high strength aluminum profile and two side locks provide security against any complications.





THE OUTDOOR COMPANY

SLIDING

ΜΟΝΟ & ΔΙΠΛΟ ΚΡΥΣΤΑΛΛΟ

ΠΛΕΟΝΕΚΤΗΜΑΤΑ SLIDING  
SLIDING BENEFITS



GR Προστασία από όλες τις καιρικές συνθήκες  
EN Protection against any weather conditions





THE OUTDOOR COMPANY

SLIDING

ΜΟΝΟ & ΔΙΠΛΟ ΚΡΥΣΤΑΛΛΟ

ΠΛΕΟΝΕΚΤΗΜΑΤΑ SLIDING  
SLIDING BENEFITS



GR Επιτρέπει τον αερισμό του χώρου τους  
θερινούς μήνες

EN Allows room's ventilation during summer



SLIDING

ΜΟΝΟ & ΔΙΠΛΟ ΚΡΥΣΤΑΛΛΟ



THE OUTDOOR COMPANY

ΠΛΕΟΝΕΚΤΗΜΑΤΑ SLIDING  
SLIDING BENEFITS



**GR** Λόγω του ανοξείδωτου ατσάλινου οδηγού η κατασκευή είναι πιο ανθεκτική.

**EN** Due to the stainless steel guide, the construction is more durable.







**GR** Το σύστημα διαθέτει πόμολο με κλειδί για μέγιστη ασφάλεια.

**EN** Our system provide lock door for maximum security.

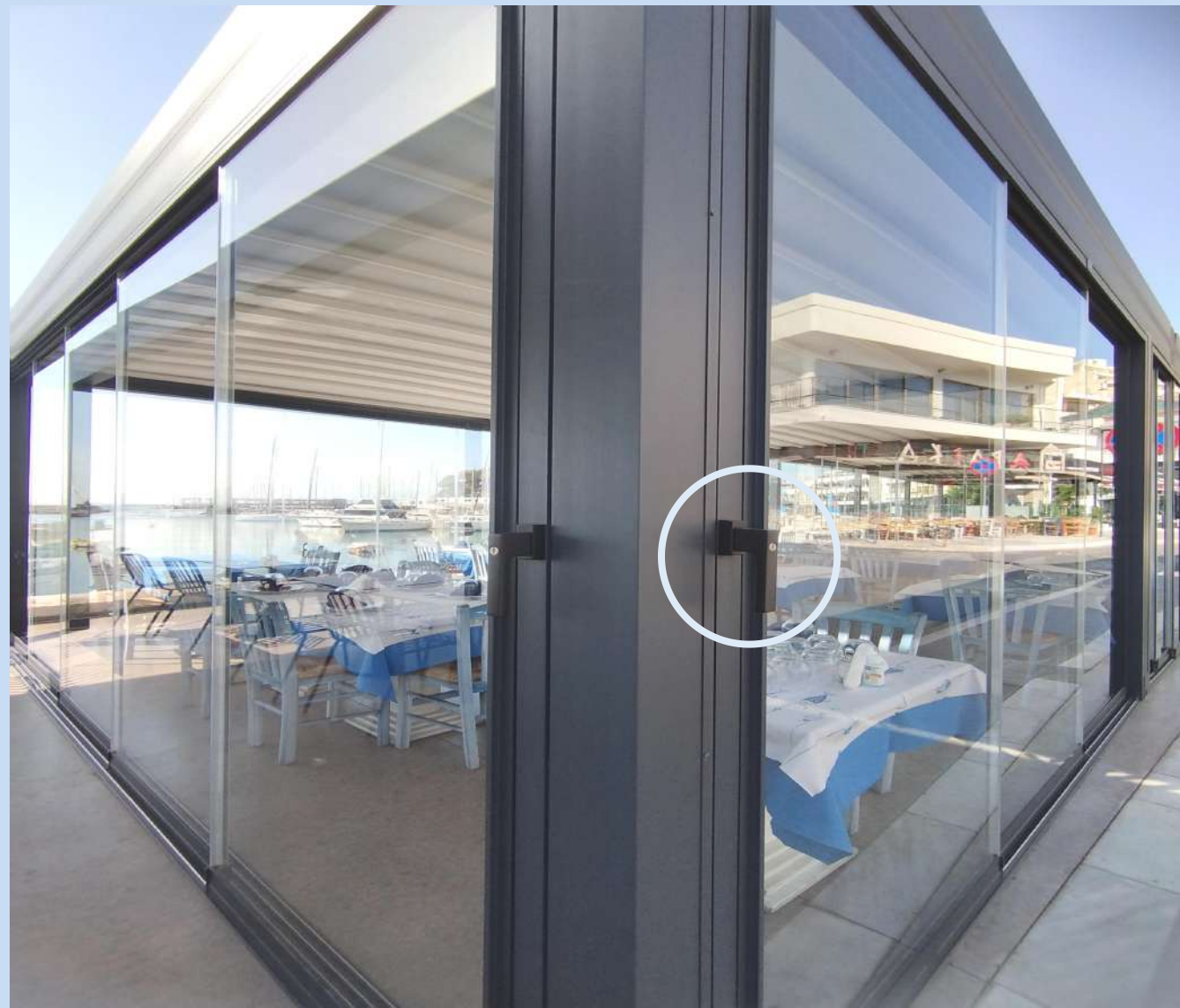





THE OUTDOOR COMPANY

SLIDING

ΜΟΝΟ & ΔΙΠΛΟ ΚΡΥΣΤΑΛΛΟ

ΠΛΕΟΝΕΚΤΗΜΑΤΑ SLIDING  
SLIDING BENEFITS



SLIDING	ΜΟΝΟ & ΔΙΠΛΟ ΚΡΥΣΤΑΛΛΟ
---------	------------------------



THE OUTDOOR COMPANY

ΤΕΧΝΙΚΑ ΧΑΡΑΚΤΗΡΙΣΤΙΚΑ  
TECHNICAL DETAILS

ΑΝΟΞΕΙΔΩΤΟΣ ΑΤΣΑΛΙΝΟΣ ΟΔΗΓΟΣ  
STAINLESS STEEL RAIL

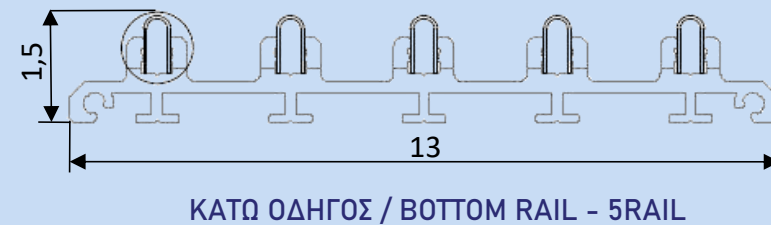
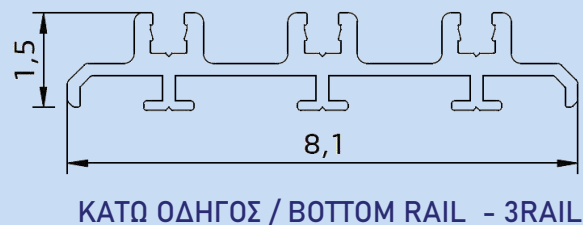
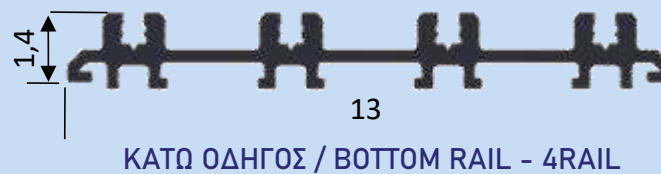

SLIDING

ΜΟΝΟ & ΔΙΠΛΟ ΚΡΥΣΤΑΛΛΟ



THE OUTDOOR COMPANY

ΤΕΧΝΙΚΑ ΧΑΡΑΚΤΗΡΙΣΤΙΚΑ  
TECHNICAL DETAILS

ΑΝΟΞΕΙΔΩΤΟΣ ΑΤΣΑΛΙΝΟΣ ΟΔΗΓΟΣ  
STAINLESS STEEL RAIL

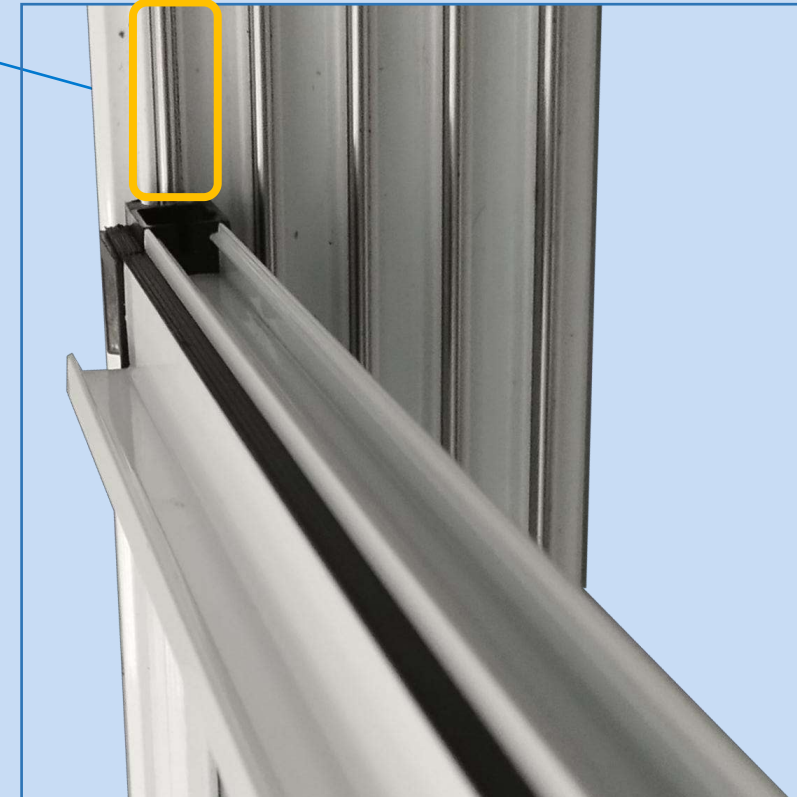
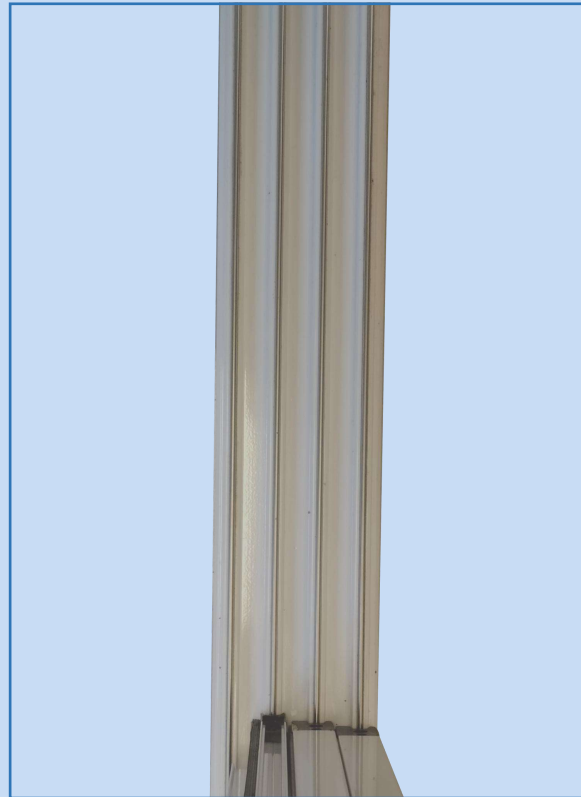



SLIDING

ΜΟΝΟ & ΔΙΠΛΟ ΚΡΥΣΤΑΛΛΟ



THE OUTDOOR COMPANY

ΤΕΧΝΙΚΑ ΧΑΡΑΚΤΗΡΙΣΤΙΚΑ  
TECHNICAL DETAILS

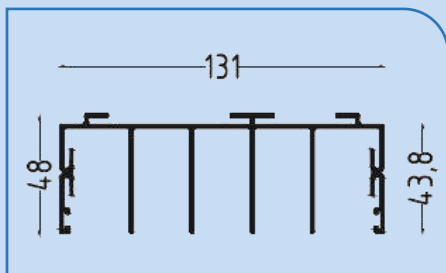

ΑΝΩ ΟΔΗΓΟΣ / UPPER RAIL - 5RAIL

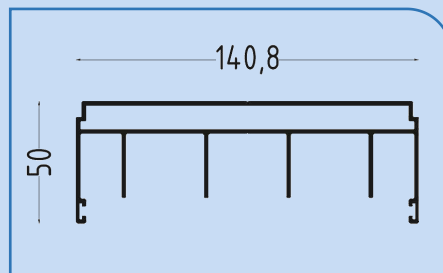

ΑΝΩ ΟΔΗΓΟΣ / UPPER RAIL - 4RAIL

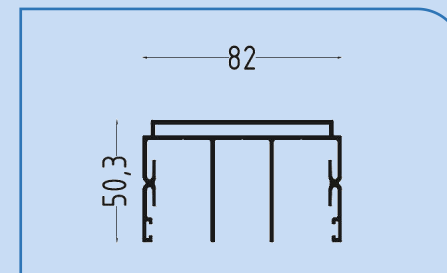

ΑΝΩ ΟΔΗΓΟΣ / UPPER RAIL - 3RAIL

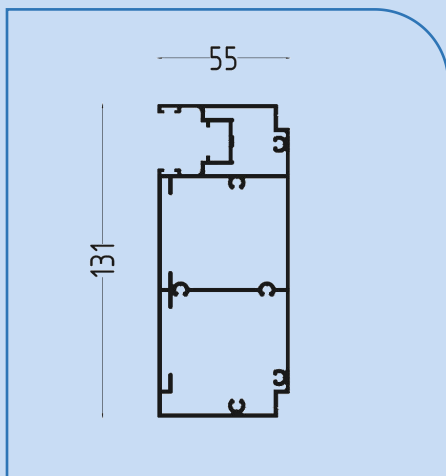

ΠΛΑΪΝΟ ΠΡΟΦΙΛ / SIDE COLUMNS - 5RAIL

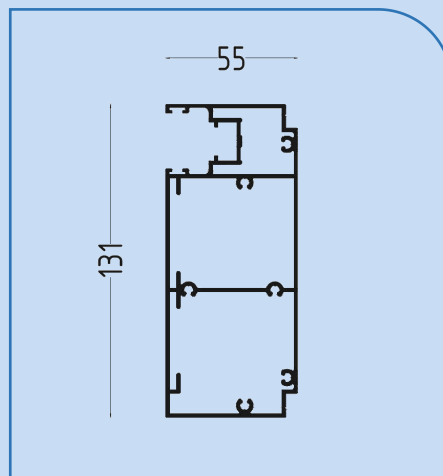

ΠΛΑΪΝΟ ΠΡΟΦΙΛ / SIDE COLUMNS - 4RAIL

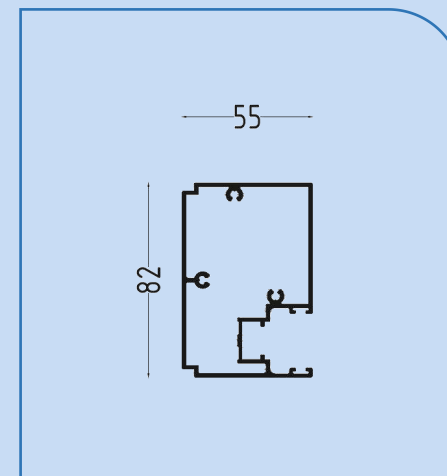

ΠΛΑΪΝΟ ΠΡΟΦΙΛ / SIDE COLUMNS - 3RAIL

SLIDING

ΜΟΝΟ & ΔΙΠΛΟ ΚΡΥΣΤΑΛΛΟ



THE OUTDOOR COMPANY

## ΤΕΧΝΙΚΑ ΧΑΡΑΚΤΗΡΙΣΤΙΚΑ TECHNICAL DETAILS

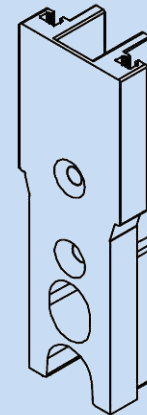

**GR** Ανοξείδωτη μεταλλική τάπα, η οποία επιτρέπει στο ένα φύλλο να παρασύρει το άλλο.

Βάφεται σε χρώμα RAL της επιλογής σας, όπως το υπόλοιπο σύστημα.

**EN** Stainless steel cap which allow one panel to carry away the other.





THE OUTDOOR COMPANY

SLIDING

ΜΟΝΟ ΚΡΥΣΤΑΛΛΟ

3 & 5 (ΚΑΝΑΛΙΑ) ΟΔΗΓΟΣ  
3 & 5 RAIL SYSTEM

**GR** Το σύστημα με τον οδηγό τριών (3) και πέντε (5) καναλιών και το μονό κρύσταλλο κατασκευάζεται με προφίλ αλουμινίου είτε με σφραγιστικό μεταξύ των φύλλων

**EN** The 3 rail and 5 rail system with single - securit glass is made of frame or transparent pvc between the panels

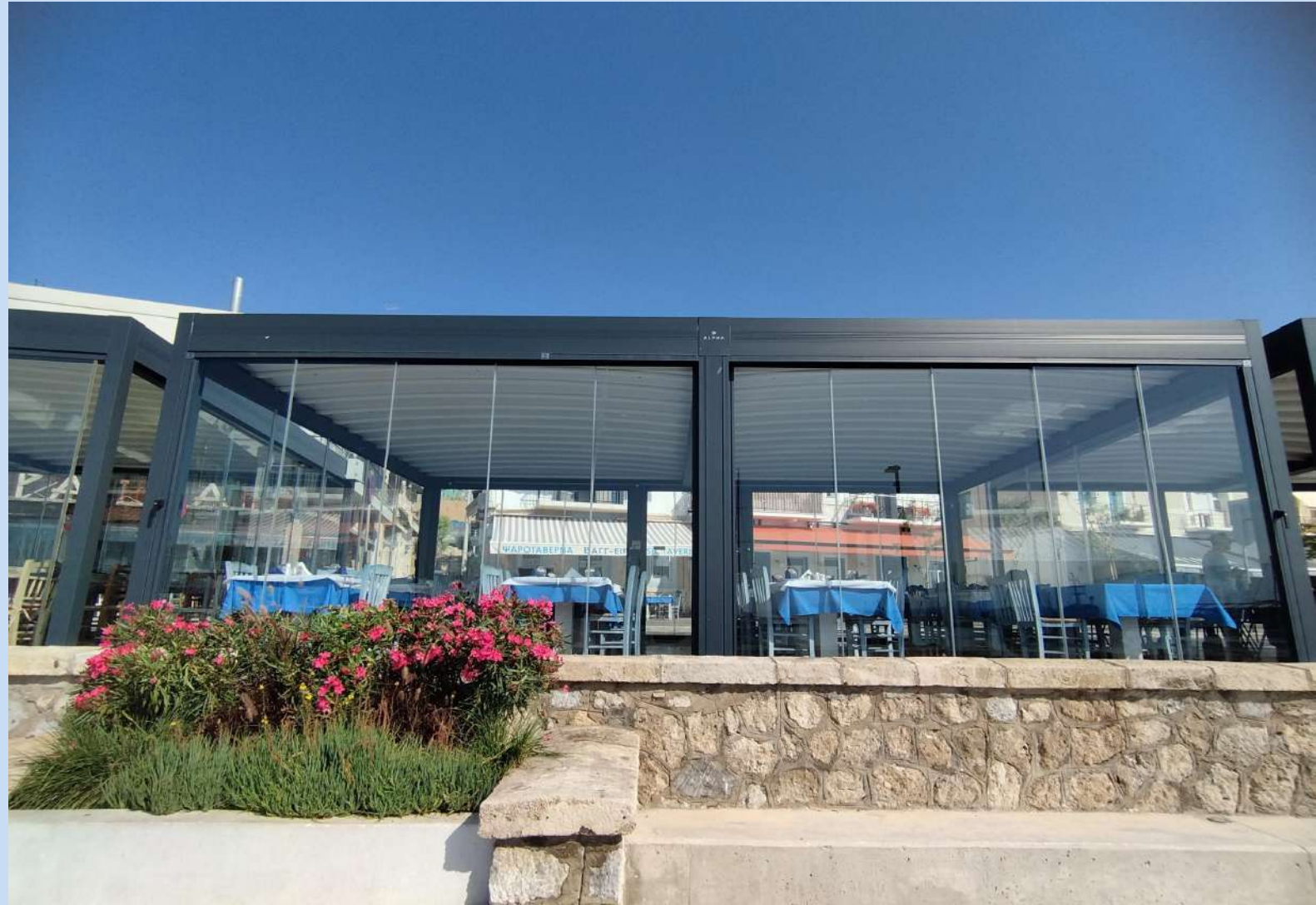



SLIDING

ΜΟΝΟ ΚΡΥΣΤΑΛΛΟ

3 (ΚΑΝΑΛΙΑ) ΟΔΗΓΟΣ  
3-RAIL SYSTEM

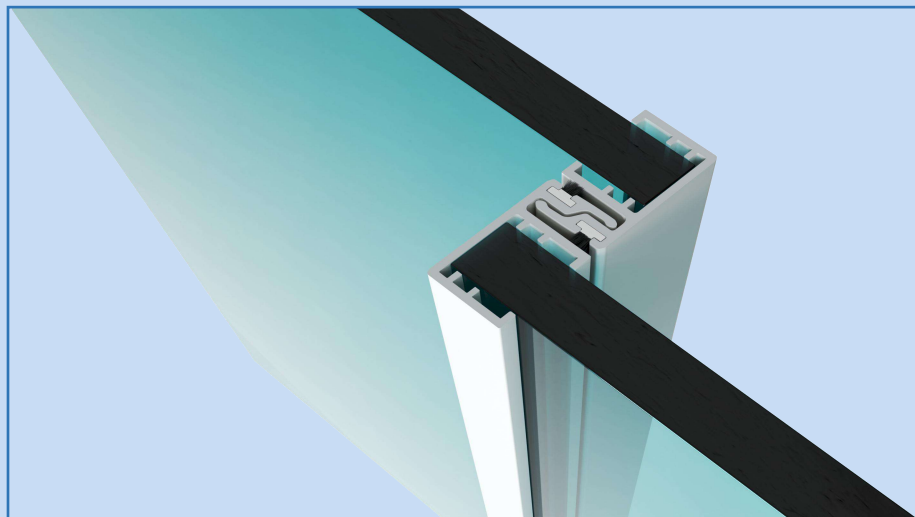
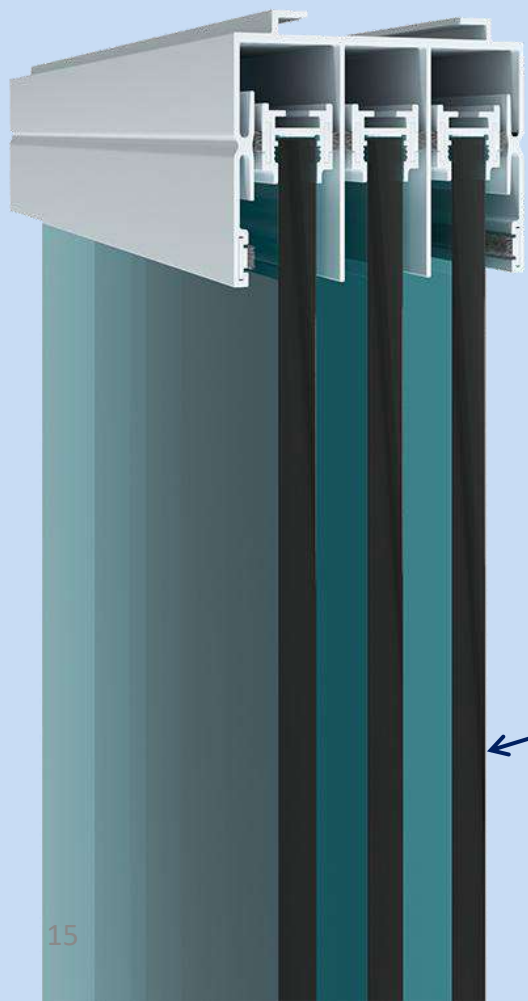

10mm SECURIT

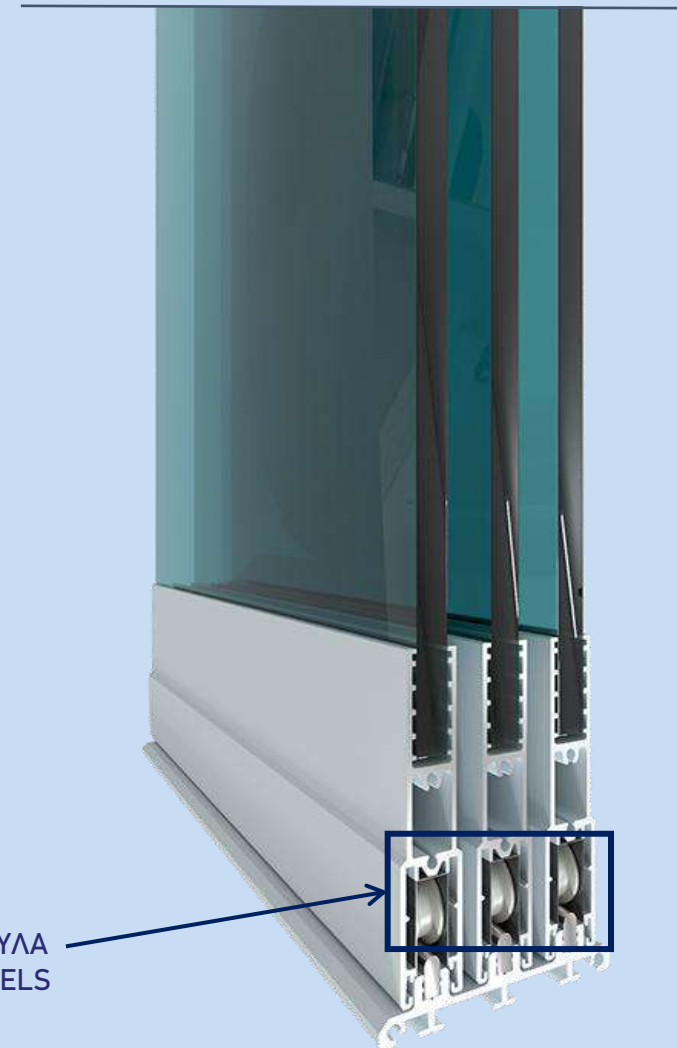

ΡΑΟΥΛΑ  
WHEELS



SLIDING

ΜΟΝΟ ΚΡΥΣΤΑΛΛΟ

3 (ΚΑΝΑΛΙΑ) ΟΔΗΓΟΣ  
3-RAIL SYSTEM

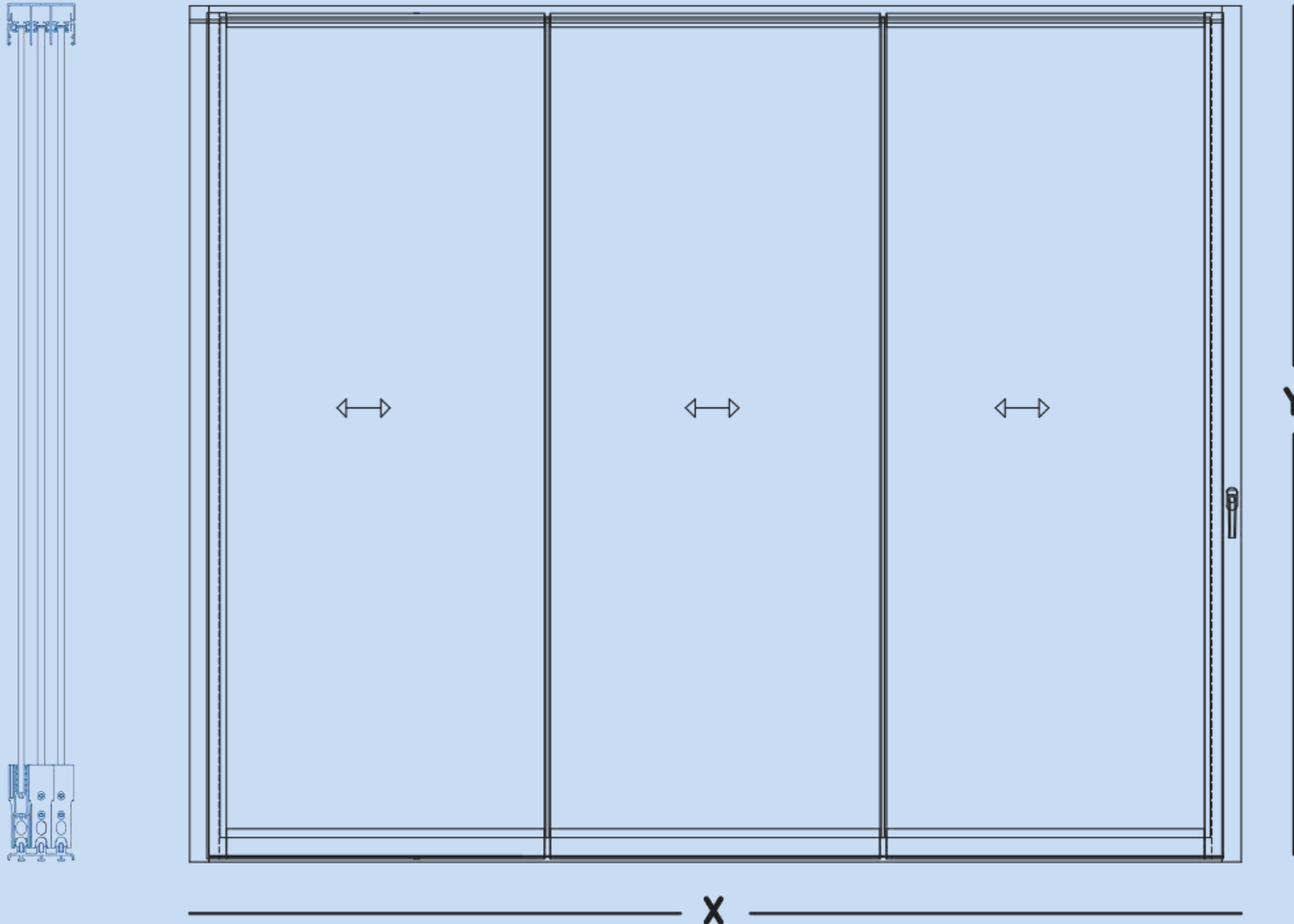

GR

Μέγιστο Πλάτος Φύλλου 1200mm

Μέγιστο Ύψος Φύλλου 3000mm

EN

Maximum panel width 1200mm

Maximum panel height 3000mm

SLIDING

ΜΟΝΟ ΚΡΥΣΤΑΛΛΟ

ΠΙΘΑΝΟΙ ΣΥΝΔΥΑΣΜΟΙ  
 POSSIBLE LAYOUTS

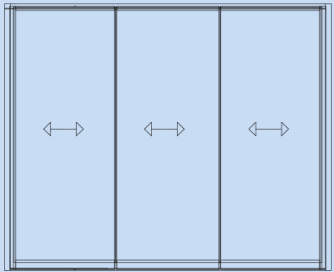

3 RAIL SINGLE GLASS  
 SLIDING 3 PANELS

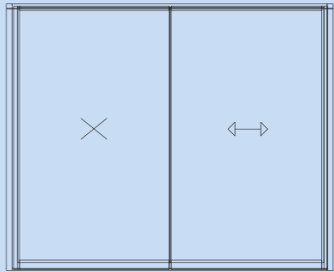
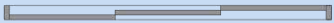

3 RAIL SINGLE GLASS  
 SLIDING 2 PANELS

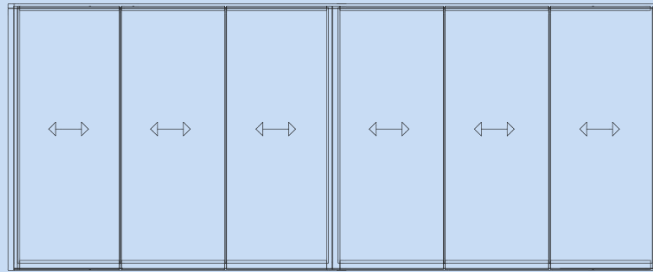

3 RAIL SINGLE GLASS SLIDING  
 3+3 PANELS

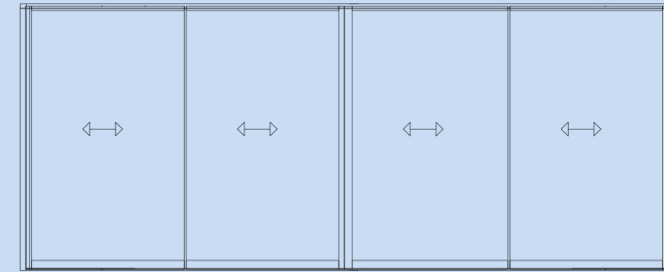
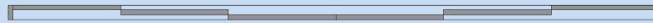

3 RAIL SINGLE GLASS SLIDING  
 2+2 PANELS

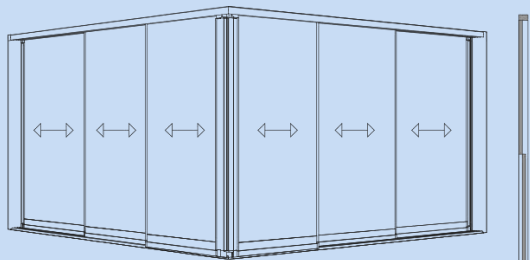

SINGLE GLASS 3+3  
 EDGE SLIDING

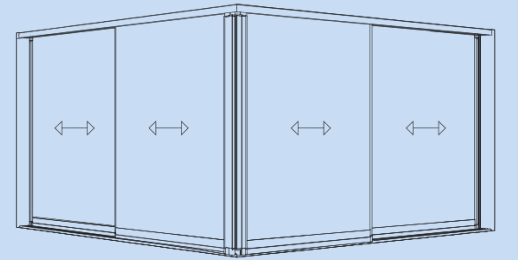

SINGLE GLASS 2+2  
 EDGE SLIDING







THE OUTDOOR COMPANY

SLIDING

ΜΟΝΟ ΚΡΥΣΤΑΛΛΟ

5 (ΚΑΝΑΛΙΑ) ΟΔΗΓΟΣ  
5-RAIL SYSTEM

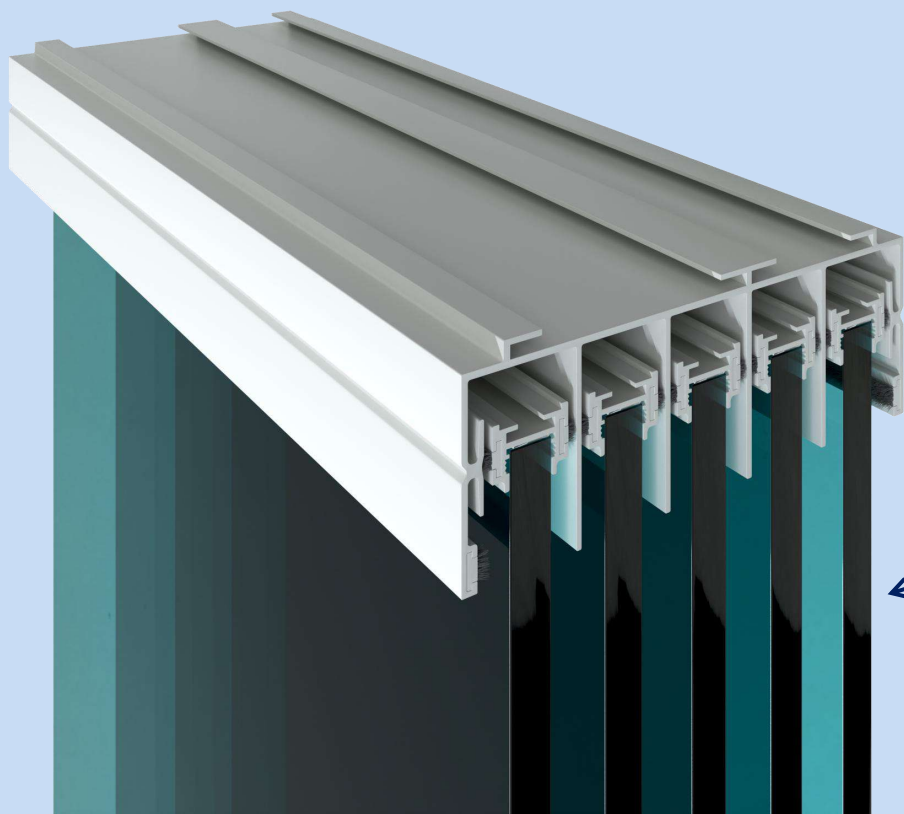

10mm SECURIT

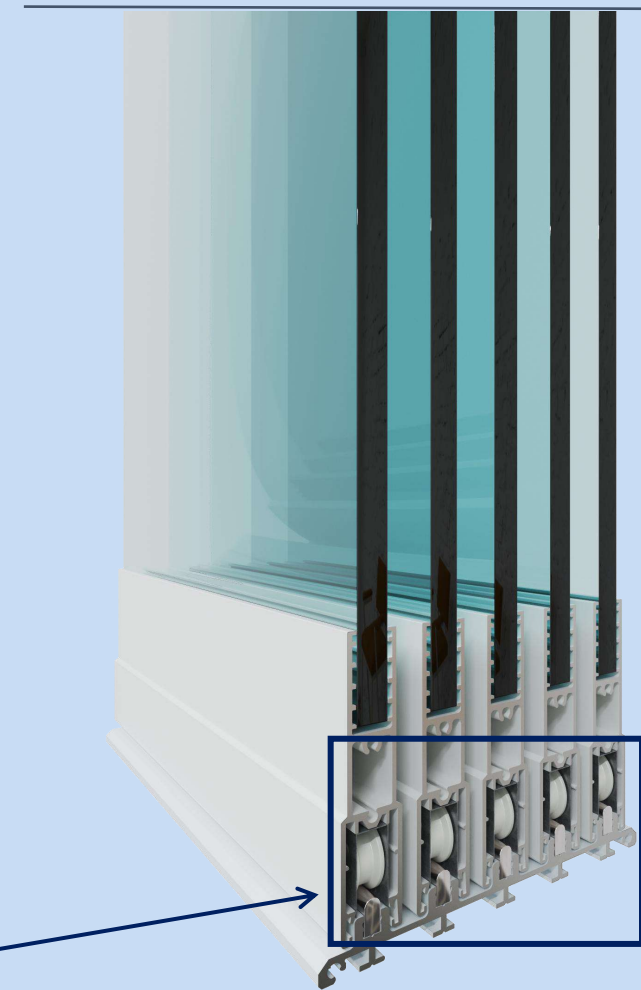

ΡΑΟΥΛΑ



SLIDING

ΜΟΝΟ ΚΡΥΣΤΑΛΛΟ



THE OUTDOOR COMPANY

ΣΥΣΤΗΜΑ ΧΩΡΙΣ ΠΕΡΙΜΕΤΡΙΚΟ ΠΡΟΦΙΛ ΑΛΟΥΜΙΝΙΟΥ  
FRAMELESS SYSTEM



ΣΦΡΑΓΙΣΤΙΚΟ  
TRANSPARENT PVC

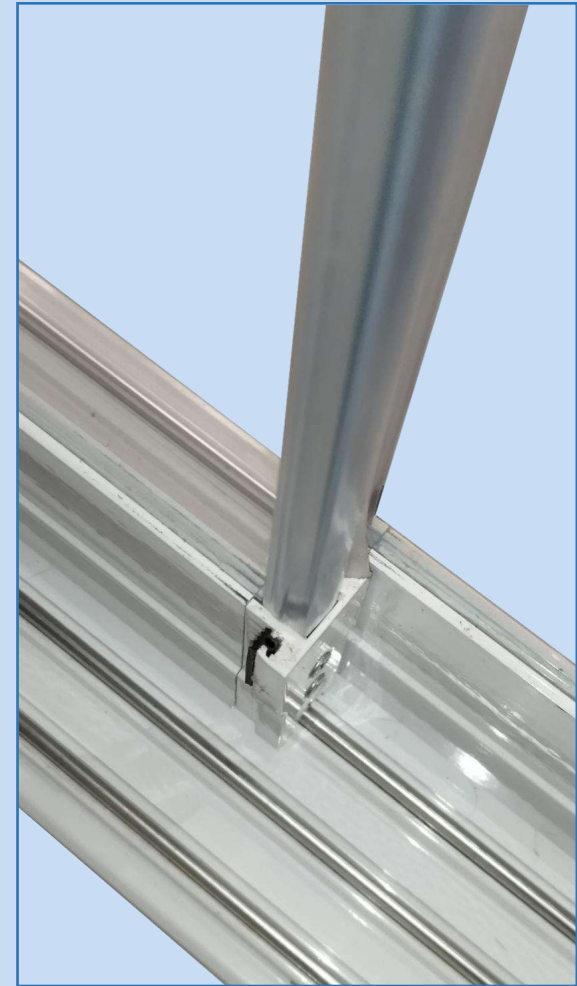
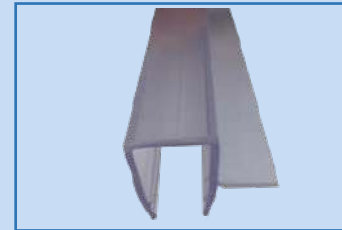

SLIDING

ΜΟΝΟ ΚΡΥΣΤΑΛΛΟ



THE OUTDOOR COMPANY

ΣΥΣΤΗΜΑ ΜΕ ΠΕΡΙΜΕΤΡΙΚΟ ΠΡΟΦΙΛ ΑΛΟΥΜΙΝΙΟΥ  
SYSTEM WITH FRAME

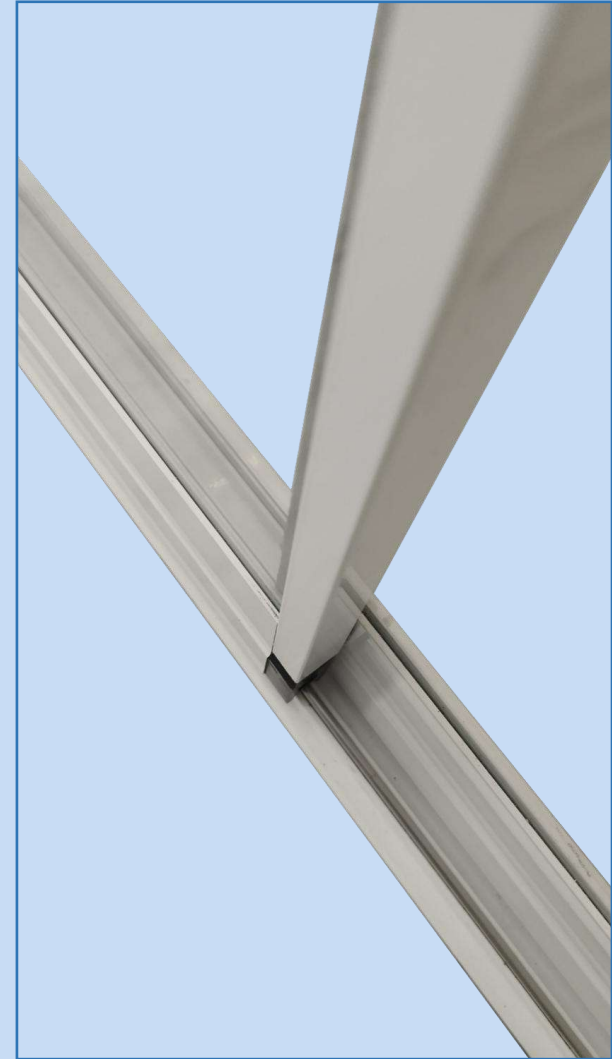
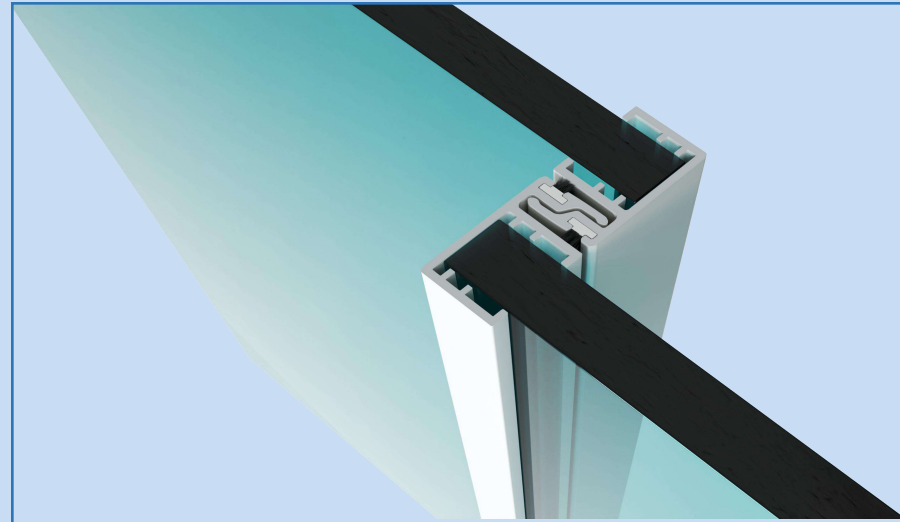



SLIDING

ΜΟΝΟ ΚΡΥΣΤΑΛΛΟ

5 (ΚΑΝΑΛΙΑ) ΟΔΗΓΟΣ  
5-RAIL SYSTEM

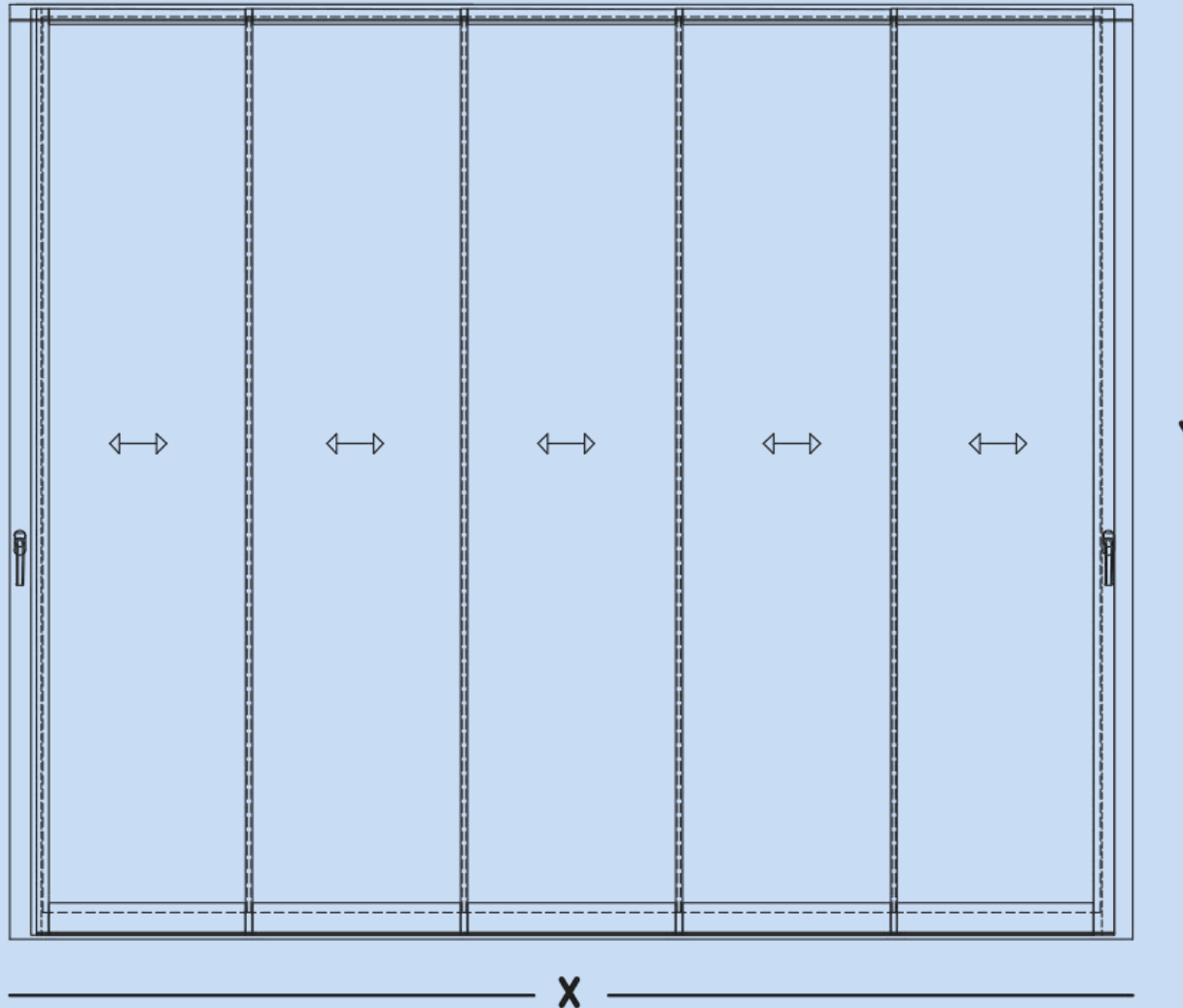

GR

Μέγιστο Πλάτος Φύλλου 1200mm

Μέγιστο Ύψος Φύλλου 3000mm

EN

Maximum panel width 1200mm

Maximum panel height 3000mm

SLIDING

ΜΟΝΟ ΚΡΥΣΤΑΛΛΟ

ΠΙΘΑΝΟΙ ΣΥΝΔΥΑΣΜΟΙ  
 POSSIBLE LAYOUTS

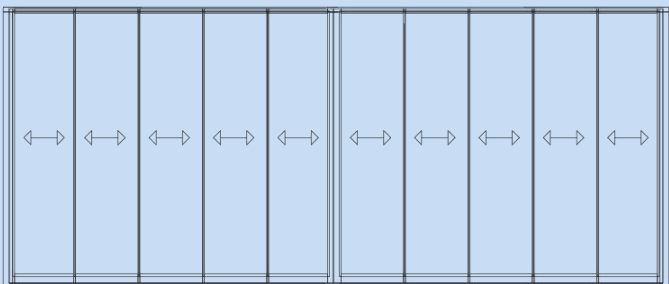

5 RAIL SINGLE GLASS SLIDING  
 5+5 PANELS

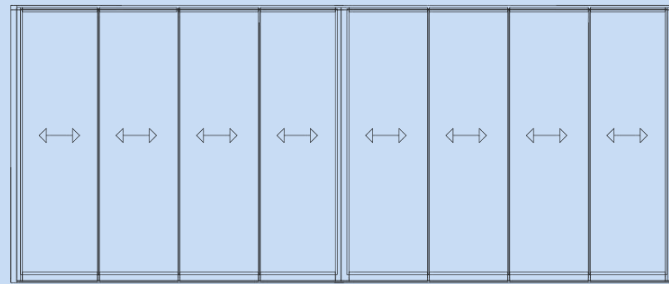
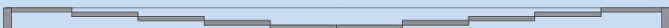

5 RAIL SINGLE GLASS SLIDING  
 4+4 PANELS

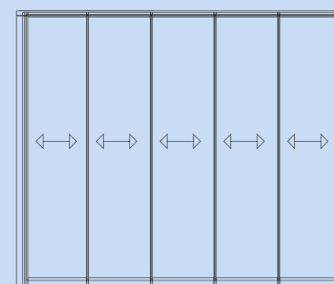
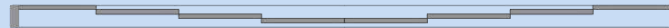

5 RAIL SINGLE GLASS  
 SLIDING 5 PANELS

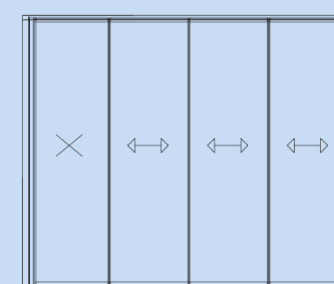
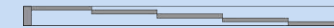

5 RAIL SINGLE  
 GLASS SLIDING  
 4 PANELS

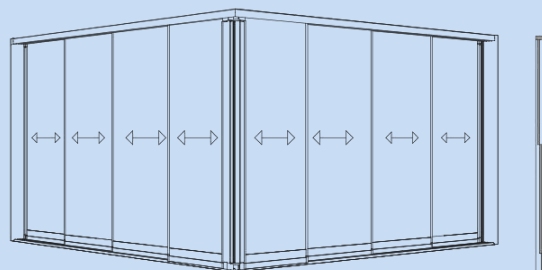

SINGLE GLASS 4+4  
 EDGE SLIDING

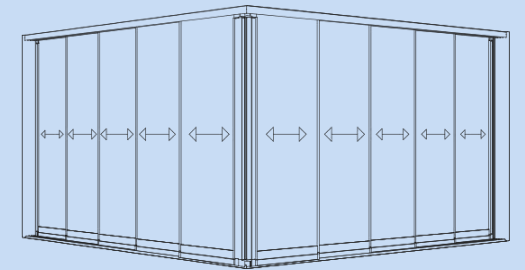

SINGLE GLASS 5+5  
 EDGE SLIDING



SLIDING

ΔΙΠΛΟ ΚΡΥΣΤΑΛΛΟ



THE OUTDOOR COMPANY

4 (ΚΑΝΑΛΙΑ) ΟΔΗΓΟΣ  
4-RAIL SYSTEM

**GR** Το σύστημα με τον οδηγό τεσσάρων (4) καναλιών και το διπλό κρύσταλλο υποστηρίζεται πάντα από προφίλ αλουμινίου μεταξύ των φύλλων

**EN** The 4 rail system with thermal glass is always supported by aluminum frame between the panels





SLIDING

ΔΙΠΛΟ ΚΡΥΣΤΑΛΛΟ



THE OUTDOOR COMPANY

4 (ΚΑΝΑΛΙΑ) ΟΔΗΓΟΣ  
4-RAIL SYSTEM

4 (ΚΑΝΑΛΙΑ) ΟΔΗΓΟΣ  
4-RAIL SYSTEM

**GR** Το σύστημα με τον οδηγό τεσσάρων (4) καναλιών και το διπλό κρύσταλλο υποστηρίζεται πάντα από προφίλ αλουμινίου μεταξύ των φύλλων

**EN** The 4 rail system with thermal glass is always supported by aluminum frame between the panels

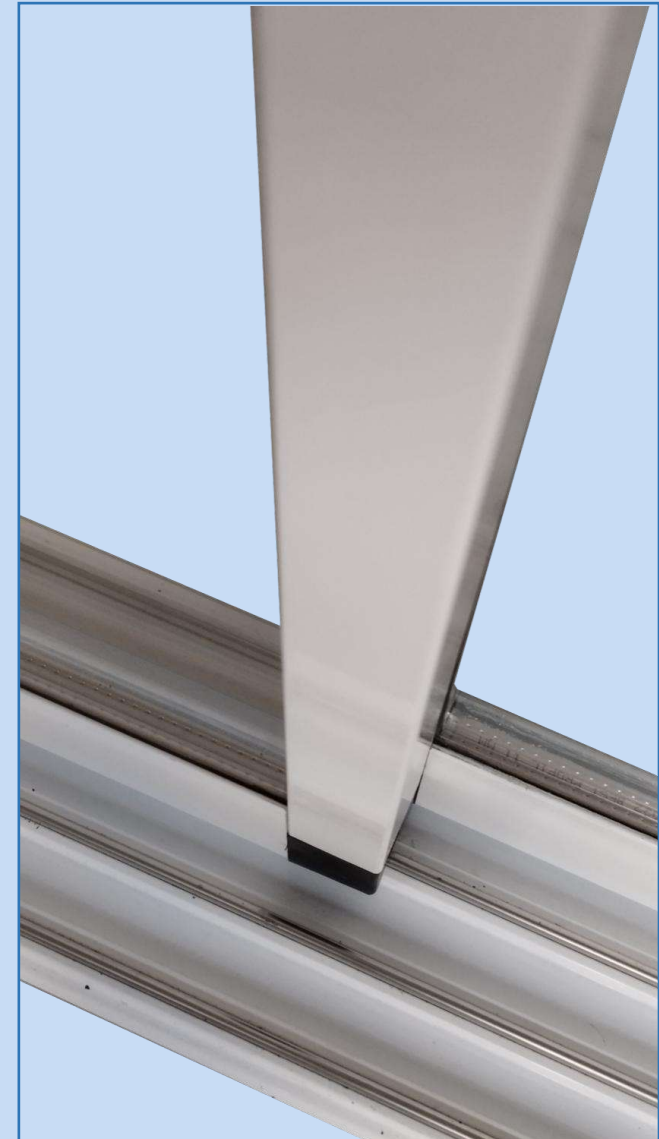

SLIDING

ΔΙΠΛΟ ΚΡΥΣΤΑΛΛΟ



THE OUTDOOR COMPANY

4 (ΚΑΝΑΛΙΑ) ΟΔΗΓΟΣ  
4-RAIL SYSTEM

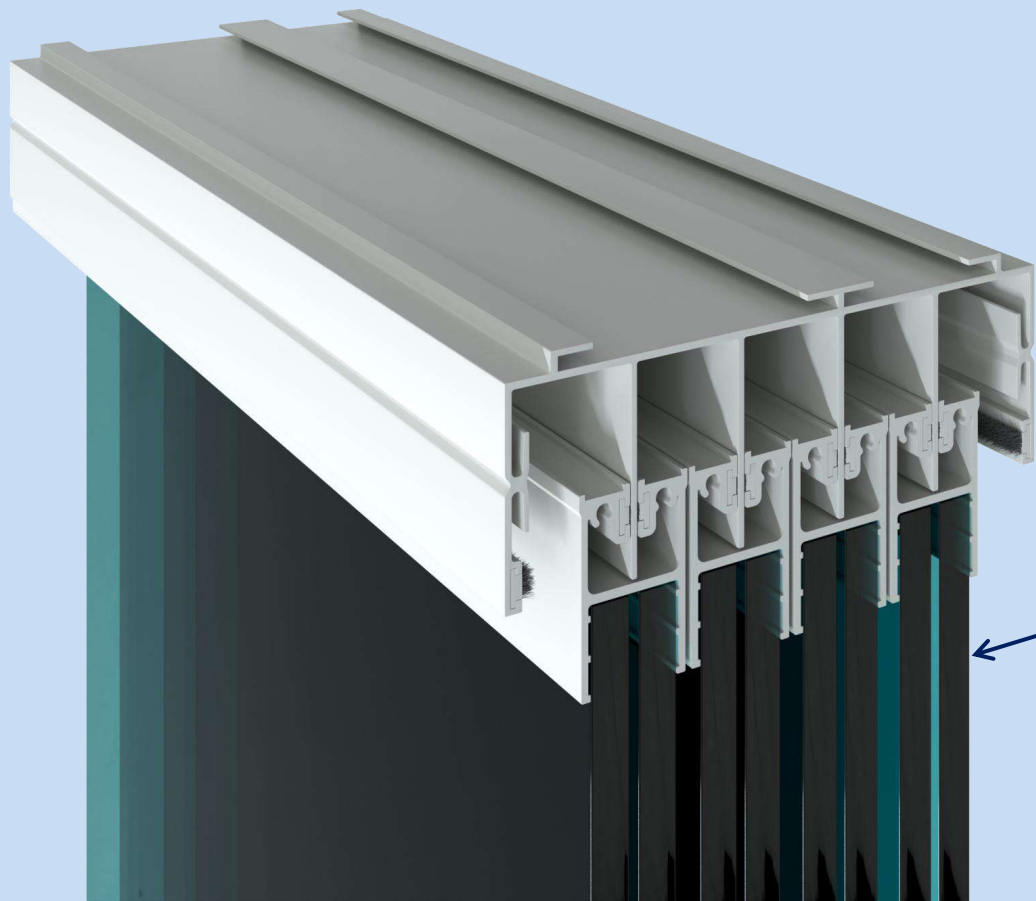

5+12+5mm  
thermal glass

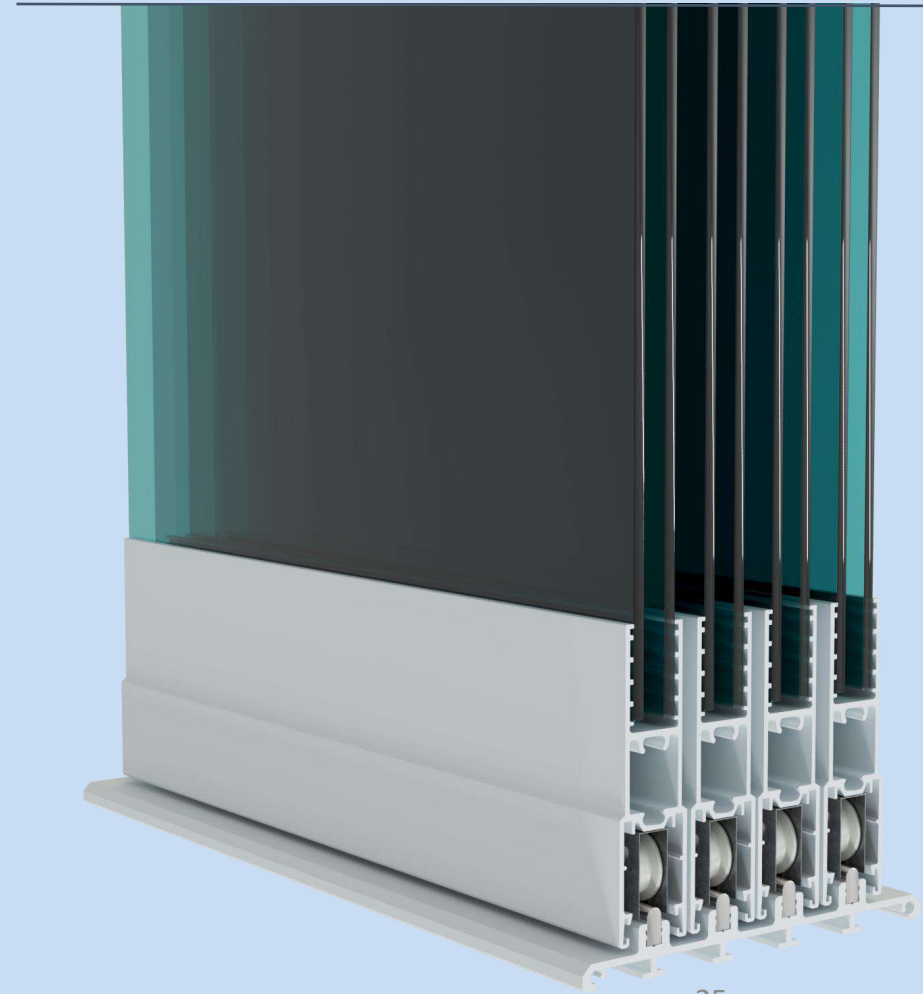

SLIDING

ΔΙΠΛΟ ΚΡΥΣΤΑΛΛΟ

4 (ΚΑΝΑΛΙΑ) ΟΔΗΓΟΣ  
4-RAIL SYSTEM

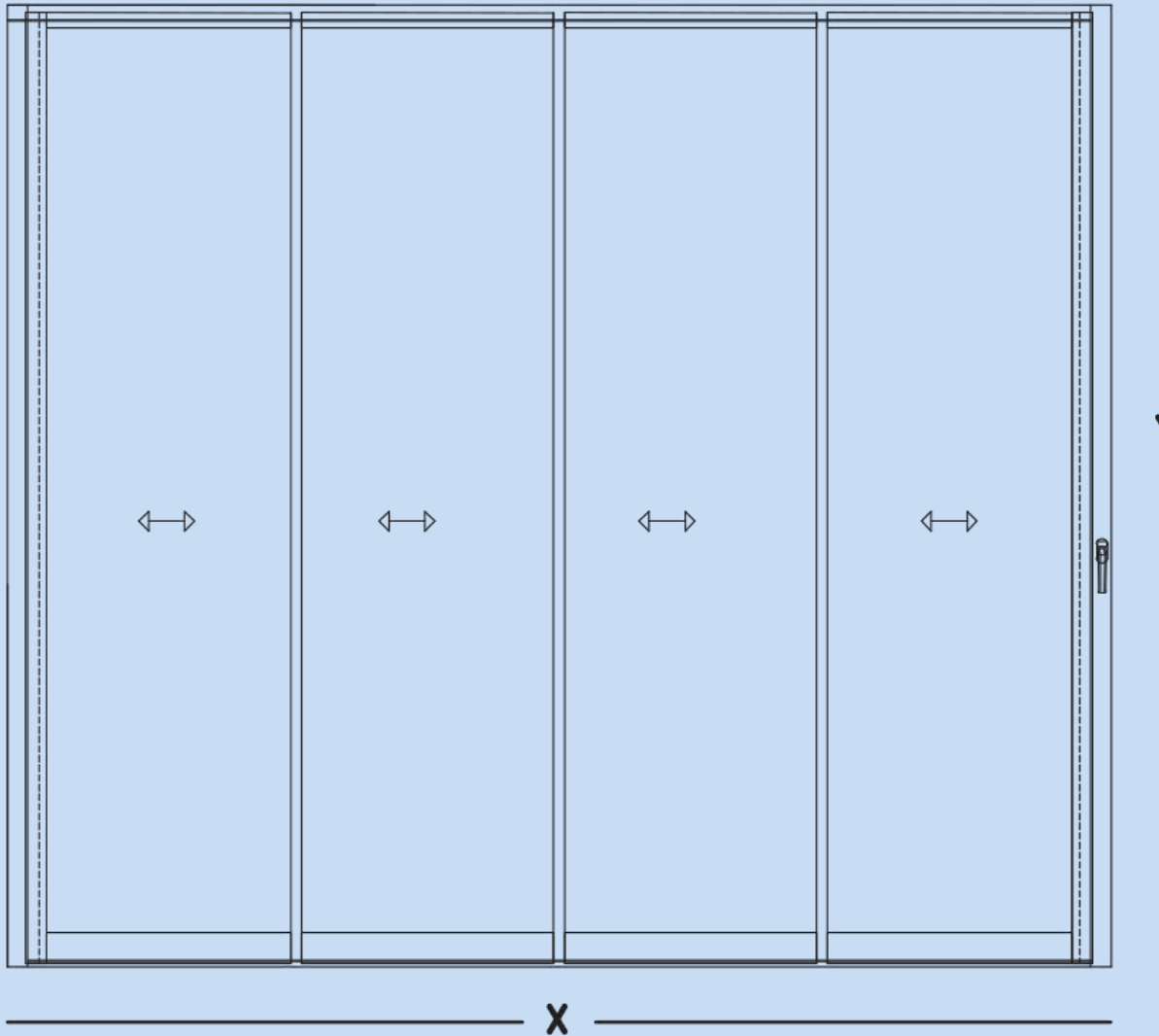

GR

Μέγιστο Πλάτος Φύλλου 1200mm

Μέγιστο Ύψος Φύλλου 3000mm

EN

Maximum panel width 1200mm

Maximum panel height 3000mm



SLIDING

ΔΙΠΛΟ ΚΡΥΣΤΑΛΛΟ

ΠΙΘΑΝΟΙ ΣΥΝΔΥΑΣΜΟΙ  
POSSIBLE LAYOUTS



THERMAL SLIDING 4+4 PANELS

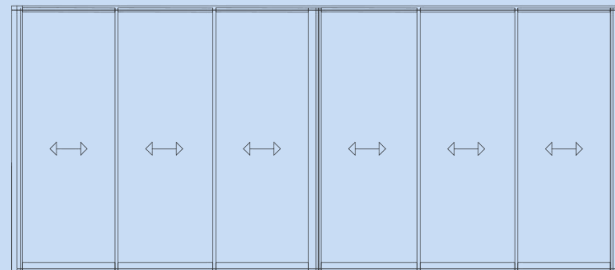
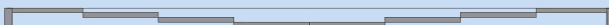

THERMAL SLIDING 3+3 PANELS

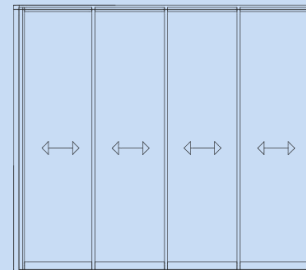

THERMAL SLIDING  
4 PANELS

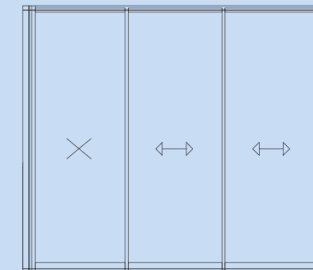

THERMAL SLIDING  
3 PANELS

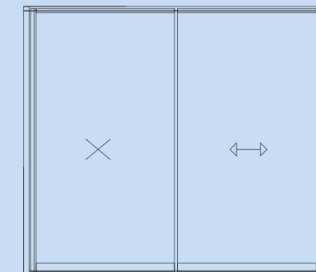
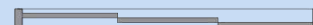

THERMAL SLIDING  
2 PANELS

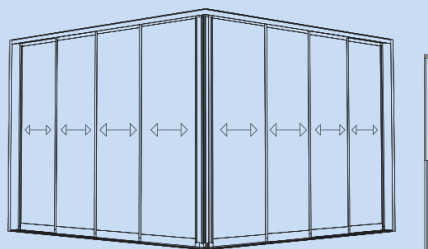
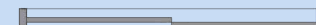

THERMAL GLASS 4+4  
EDGE SLIDING

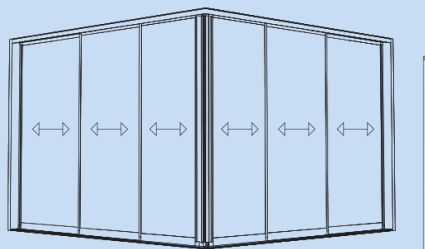

THERMAL GLASS 3+3  
EDGE SLIDING

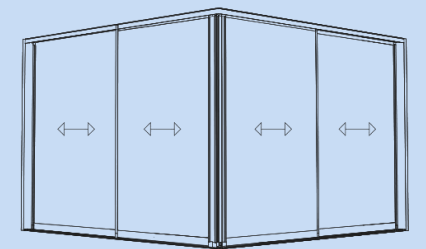

THERMAL GLASS 2+2  
EDGE SLIDING



SLIDING

ΗΛΕΚΤΡΟΣΤΑΤΙΚΗ ΒΑΦΗ RAL



THE OUTDOOR COMPANY

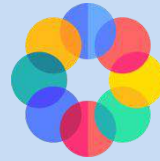

ΦΥΣΙΚΗ ΑΝΟΔΙΩΣΗ

ή

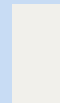

RAL 9016



RAL 1013



RAL 9006



RAL 7016



RAL 9005



+ άλλες  
χρωματικές  
επιλογές